

## Installation Guide



## 2.0 Description

The Push Button LED Dimmer is an Integrally Switched, Push Button, modular dimmer mechanism rated at 350 VA. Up to six dimmer mechanisms can be installed in a plate.

Designed for LED lamps, the unit utilises powerful and sophisticated dimming technology to provide control.

The LED Dimmer also incorporates over-current and thermal fuse cutoff (non-recoverable) protection devices and is capable of withstanding persistent short circuit conditions.

## 3.0 Features

- Integrally switched modular dimming mechanism
- 350 VA Power Rating
- Two-wire phase control wall plate dimmer.
- Soft-start for lamp and driver life.
- Provide optimised dimming of LED based lamps and drivers.
- Compatibility with incandescent lamps, 240 V halogen lamps, Low voltage halogen lamp with dimmable electronic transformer, etc
- User adjustable minimum and maximum brightness
- Multi-gang capacity up to six (6) dimmer mechanisms per plate
- Wall or architrave mounting options.
- Wide range of plate styles and colour variants available.
- Suitable for new installations or retro-fit applications.
- Inbuilt Over-Current and Over-Temperature protection.
- Full short circuit protection.
- Immune to high frequency (ripple) signal injection on mains supply.
- Complies with Australian and International EMC Standards.

## 4.0 Dimmer Unit Operation

<b>Dimming</b>	Long press dimming button to dimming
<b>ON/OFF</b>	Short press dimming button to on/off
<b>Programming</b>	<b>Minimum brightness setting</b> 1) Remove the top cap 2) Long press programming button until LED flash (Slow flashing) 3) Long press dimming button to the setting level 4) Double press dimming button to exit programming mode
	<b>Maximum brightness setting</b> 1) Remove the top cap 2) Long press programming button until LED flash, short press programming button, LED start to flash fast 3) Long press dimming button to the setting level 4) Double press dimming button to exit programming mode

## Table of Contents

<b>Section</b> .....	
1.0 Product Range .....	
2.0 Description .....	
3.0 Features .....	
4.0 Dimmer Unit Operation .....	
5.0 LED Indicator .....	
6.0 Electrical Specification .....	
7.0 Load Compatibility .....	
8.0 Incompatible Loads .....	
9.0 Wiring Diagram .....	
10.0 Installation .....	
11.0 Warranty Statement .....	

## 1.0 Product Range

Product No.	Description
PBD350VA	Push Button LED Dimmer

## 5.0 LED Indicator



The unit incorporates an LED indicator to display the status of the load.

LOAD STATUS	INDICATOR STATUS
ON	ON
OFF	OFF

## 6.0 Electrical Specification

Parameter	Value
Nominal Operating Voltage	220-240 V~
Nominal Operating Frequency	50 Hz
Maximum Load	350 VA @1 Gang Derate for multi-gang applications
Minimum Load	10 VA
Dimming Technique	Trailing Edge Phase Control
Mounting Centres	84mm Australian Pattern Plate
Safety Compliance	AS/NZS 3100, AS/NZS 3133, IEC 60669-2-1
EMC Compliance	AS/NZS CISPR15, IEC 60669-2-1 (26.1, 26.2), IEC 61000-3-2 (Excepting when used in conjunction with Electronic loads)
Specifications Typical @ 240 V~ 25°C	
Suitable for Indoor Use Only	
No User Serviceable Parts Inside	

## 7.0 Load Compatibility

Load Symbol	Compatible Loads	JB-DM-PBD350VA	
		Maximum Load	Minimum Load
	Dimmable LED Lighting	150 W	10 W
	Incandescent Lighting 240 V Halogen Lamps	350 W	10 W
	Low Voltage Halogen Lighting with Electronic Transformers	350 VA	10 VA

## 8.0 Incompatible Loads

This dimmer is not compatible for use with non-dimmable linear or compact fluorescent lamps. Use only lamps / ballasts that are compatible with phase angle control.

## 9.0 Wiring Diagram

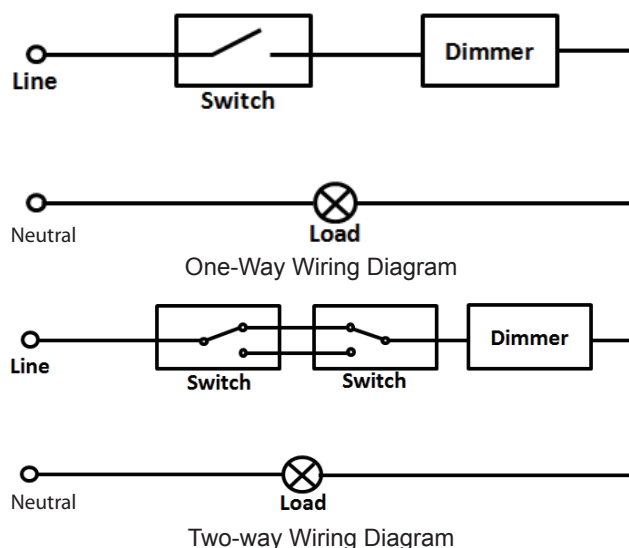



### NOTE:

- The LED dimmer series are designed for One-Way or Two-Way operation as above diagrams.
- Two or more dimmers cannot be connected in parallel or series to control the same load from two different locations.
- Dimmer Mechanism wiring is NOT polarity sensitive

**It is illegal for persons other than an appropriately licensed electrical contractor or other persons authorised by legislation to work on the fixed wiring of any electrical installation. Penalties for conviction are severe.**

## 10.0 Installation

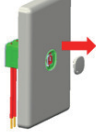
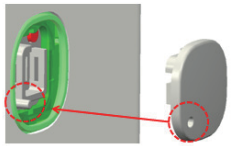
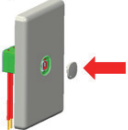
To connect the required lighting loads, then follow the following steps:

<p><b>Step 1</b></p> <p>Leave the dimmer connected, but remove the dimming cap from the top button of the dimmer.</p> 	<p><b>Step 2</b></p> <p>Align the pillar on the front of the top button with the hole in the cap of dimmer.</p> 
<p><b>Step 3</b></p> <p>Push the dimmer cap back and make sure the pillar insert the hole and all the snap-fit structure assembly successfully.</p> 	<p>You can choose one kind of the caps when you buy this dimmer, to meet different style of products.</p> 

## 11.0 Warranty Statement

- This product is guaranteed against faulty workmanship and materials for a period of three years from the date of installation.
- This warranty is expressly subject to the product being installed, wired, tested, operated and used in accordance with the manufacturer's instructions.
- There are no user serviceable parts. For any warranty issues return to supplier.